

**M12 MALE 0° / M12 FEMALE 0° SHIELDED MASI**

PUR 2x1,0 shielded GRAY, drag ch 7m

## AS-Interface

The resistance to aggressive media should be individually tested for your application. Further details on request.  
Further cable lengths on request.

Male straight – female straight  
shielded

Male M12

4-pole

2-pole used

Female M12

2-pole

Plastic housings with good resistance against chemicals and oils.

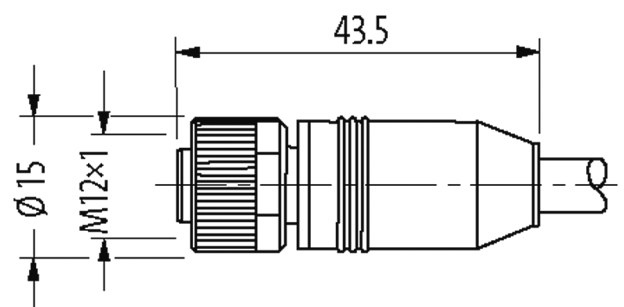
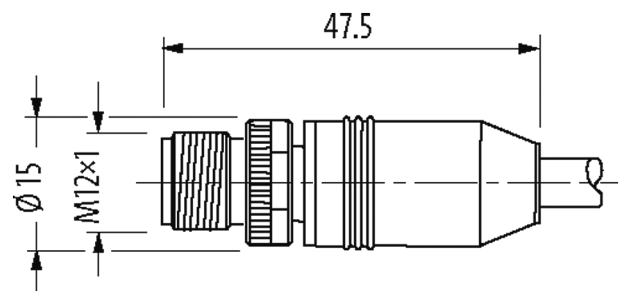
[Link to Product](#)**Illustration**

Product may differ from Image

**Approvals****More Info**



Form	
Form	40485
General data	
Standards	DIN EN 61076-2-101 (M12)
Pollution Degree	3
Mounting method	inserted, tightened
Cables	
Cable number	542
No./diameter of wires	2x 1.0 mm <sup>2</sup>
Wire isolation	PP (br, bl)
C-track properties	5 Mio.
Jacket Color	gray
Material (jacket)	PUR (UL/CSA)
Outer Ø	8.0 mm ±5%
Bend radius (moving)	15x outer Ø
Temperature range (fixed)	-40...+80 °C
Temperature range (mobile)	-25...+60 °C
Cable identification	542
Approval (cable)	UL (AWM-Style 21198/10493), CSA
Cable weight [g/m]	82,50
Material (wire)	Cu wire, bare
Resistor (core)	max. 19.5 Ω/km (20 °C)
Single wire Ø (core)	0.15 mm
Construction (core)	55x 0.15 mm (multi-strand wire class 6)
Diameter (core)	2x 1.0 mm <sup>2</sup>
AWG	similar to AWG 17
Material (wire isolation)	PP
Material property (wire isolation)	CFC-, halogen-, cadmium-, silicone- and lead-free
Shore hardness (wire isolation)	70 ±5 D
Wire-Ø incl. isolation	2.7 mm ±5%
Color/numbering of wires	br, bl
Shield	yes
	min. 80%
Material (jacket)	PUR
Material property (jacket)	CFC-, halogen-, cadmium-, silicone- and lead-free, matt, low-adhesion, machine easy to process, abrasion-resistant, hydrolysis and microbial resistant
Shore hardness (jacket)	90 ±5 A
Outer-Ø (jacket)	8.0 mm ±5%
Color (jacket)	gray
chemical resistance	good resistance to oil, gasoline and chemicals (VDE 0472 Teil 803 Test B)
thermal resistance	flame retardant UL, CSA FT2 / IEC 60332-2-2
Nominal voltage	300 V AC
Test voltage	2000 V AC
Current load capacity	to DIN VDE 0298-4

Temperature range (fixed)	-40...+80 °C
Temperature range (mobile)	-25...+60 °C
Bend radius (fixed)	10× outer Ø
Bend radius (moving)	15× outer Ø
No. of bending cycles (C-track)	max. 5 Mio. (25 °C)
Traversing distance (C-track)	max. 5 m (horizontal)
Travel speed (C-track)	max. 2 m/s
Acceleration (C-track)	max. 5 m/s <sup>2</sup>
Torsion stress	±90 °/m
No. of torsion cycles	max. 5 Mio.
Torsion speed	35 cycles/min

#### Technical Data

Operating voltage	max. 60 V AC/DC
Rated surge voltage	0.8 kV
Operating current per contact	max. 4 A
Material group	IEC 60664-1, category I
Coding	A-coded
LED display	no
Locking of ports	Screw thread (M12×1 mm) recommended torque 0.6 Nm, self-securing
Compression gland	M12 (SW13)
Protection	IP67, IP68 inserted and tightened (EN 60529)
Material	PUR
Locking material	Zinc die casting, matte nickel plated

#### Commercial data

country of origin	DE
customs tariff number	85444290
EAN	4048879433945
eClass	27279218
Packaging unit	1